

**Handles**



Code	Size CC	Overall Size	Projection	Width	Finish	Material
<b>1004</b>	96 mm	100 mm	19 mm	10 mm	BN,SN,SC	zinc alloy
	128 mm	132 mm	25 mm	11 mm		



Code	Size CC	Overall Size	Projection	Width	Finish	Material
<b>1005</b>	96 mm	105 mm	30 mm	14 mm	BN,SN,SC	zinc alloy
	128 mm	148 mm	30 mm	14 mm		



Code	Size CC	Overall Size	Projection	Width	Finish	Material
<b>1008</b>	64 mm	85 mm	18 mm	12 mm	BN,SN,SC	zinc alloy
	96 mm	118 mm	20 mm	14 mm		
	128 mm	156 mm	24 mm	16 mm		



Code	Size CC	Overall Size	Projection	Width	Finish	Material
<b>1009</b>	96 mm	140 mm	18 mm	11 mm	BN,SN,SC	zinc alloy



Code	Size CC	Overall Size	Projection	Width	Finish	Material
<b>1012</b>	96 mm	114 mm	20 mm	10 mm	BN,SN,SC	zinc alloy
	128 mm	148 mm	25 mm	10 mm		



Code	Size CC	Overall Size	Projection	Width	Finish	Material
<b>1015</b>	96 mm	112 mm	11 mm	15 mm	BN,SN,SC	zinc alloy
	128 mm	151 mm	21 mm	19 mm		



Code	Size CC	Overall Size	Projection	Width	Finish	Material
<b>1022</b>	96 mm	121 mm	19 mm	8 mm	BN,SN,SC	zinc alloy



Code	Size CC	Overall Size	Projection	Width	Finish	Material
<b>1023</b>	96 mm	126 mm	17 mm	6 mm	BN,SN,SC	zinc alloy
	128 mm	156 mm	23 mm	6 mm		



Code	Size CC	Overall Size	Projection	Width	Finish	Material
<b>1029</b>	96 mm	100 mm	12 mm	14 mm	BN,SN,SC	zinc alloy
	128 mm	131 mm	15 mm	19 mm		
	160 mm	166 mm	19 mm	25 mm		

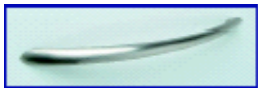

Code	Size CC	Overall Size	Projection	Width	Finish	Material
<b>0102</b>	128 mm	150 mm	27 mm	11 mm	BN	zinc alloy



Code	Size CC	Overall Size	Projection	Width	Finish	Material
<b>1045</b>	128 mm	153 mm	26 mm	13 mm	BN,SN,SC	zinc alloy







Code	Size CC	Overall Size	Projection	Width	Finish	Material
<b>1062</b>	96 mm	144 mm	19 mm	14 mm	BN,SN,SC	zinc alloy
	128 mm	182 mm	22 mm	16 mm		



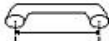



Code	Size CC	Overall Size	Projection	Width	Finish	Material
<b>1064</b>	96 mm	127 mm	17 mm	14 mm	BN,SN,SC	zinc alloy
	128 mm	161 mm	17 mm	15 mm		







						
Code	Size CC	Overall Size	Projection	Width	Finish	Material
<b>1075</b>	64 mm	102 mm	21 mm	9 mm	BN,SN,SC	zinc alloy
	96 mm	142 mm	24 mm	10 mm		
	128 mm	174 mm	29 mm	10 mm		



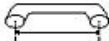



						
Code	Size CC	Overall Size	Projection	Width	Finish	Material
<b>1092</b>	64 mm	72 mm	22 mm	12 mm	BN,SN,SC	zinc alloy
	96 mm	112 mm	22 mm	12 mm		
	128 mm	131 mm	26 mm	14 mm		
	160 mm	167 mm	31 mm	14 mm		







						
Code	Size CC	Overall Size	Projection	Width	Finish	Material
<b>1211</b>	96 mm	113	27 mm	10 mm	BN,SC, PC	aluminium
	128 mm	142	27 mm	12 mm		







						
Code	Size CC	Overall Size	Projection	Diameter	Finish	Material
<b>2002</b>	96 mm	102 mm	32 mm	10 mm	SC	zinc alloy
	128 mm	138 mm	32 mm	10 mm		
	160 mm	168 mm	32 mm	10 mm		
	192 mm	200 mm	32 mm	10 mm		
	160 mm	168 mm	32 mm	10mm		



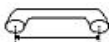



						
Code	Size CC	Overall Size	Projection	Width	Finish	Material
<b>3009</b>	128 mm	160 mm	34 mm	15 mm	BN,SN,SC	zinc alloy







						
Code	Size CC	Overall Size	Projection	Width	Finish	Material
<b>3043</b>	96 mm	115 mm	29 mm	12 mm	BN,SN,SC	zinc alloy

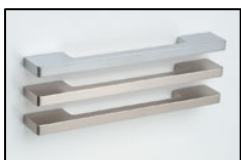





						
Code	Size CC	Overall Size	Projection	Width	Finish	Material
<b>3047</b>	128 mm	200 mm	20 mm	12 mm	BN,SN,SC	zinc alloy
	160 mm	242 mm	22 mm			

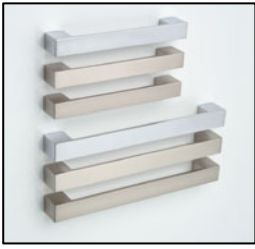

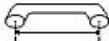



						
Code	Size CC	Overall Size	Projection	Width	Finish	Material
<b>3060</b>	160 mm	197mm	29 mm	12 mm	BN,SN,SC	zinc alloy

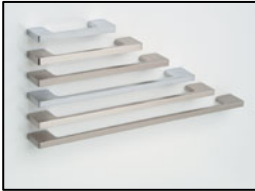





						
Code	Size CC	Overall Size	Projection	Width	Finish	Material
<b>3061</b>	128 mm	158 mm	25 mm	20 mm	BN,SN,SC	zinc alloy
	192 mm	226 mm	27 mm	24 mm		







						
Code	Size CC	Overall Size	Projection	Width	Finish	Material
<b>3064</b>	64 mm	85 mm	25 mm	8 mm	BN,SN,SC	zinc alloy
	96 mm	119 mm	26 mm	8 mm		
	128 mm	155 mm	26 mm	8 mm		
	160 mm	192 mm	27 mm	8 mm		
	192 mm	224 mm	27 mm	8 mm		
	240 mm	272 mm	27 mm	8 mm		





						
Code	Size CC	Overall Size	Projection	Width	Finish	Material
<b>3076</b>	128 mm	142 mm	19 mm	17 mm	BN,SN,SC	zinc alloy
	160 mm	179 mm	21 mm	19 mm		





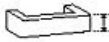

						
Code	Size CC	Overall Size	Projection	Width	Finish	Material
<b>3090</b>	128 mm	166 mm	30 mm	19 mm	BN,SN,SC	zinc alloy







						
Code	Size CC	Overall Size	Projection	Width	Finish	Material
<b>3126</b>	128 mm	179 mm	33 mm	14 mm	BN and SC	zinc alloy
	288 mm	339 mm	33 mm	14 mm		

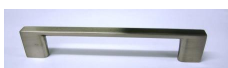





						
Code	Size CC	Overall Size	Projection	Width	Finish	Material
<b>3129</b>	128 mm	137 mm	33 mm	15 mm	BN and SC	zinc alloy
	288 mm	297 mm	33 mm	15 mm		

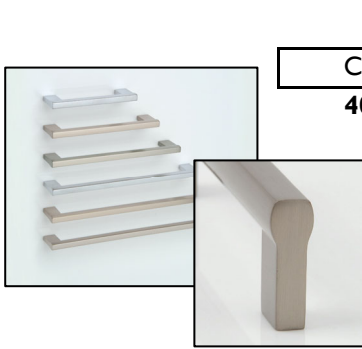





						
Code	Size CC	Overall Size	Projection	Width	Finish	Material
<b>4018</b>	96	118	23 mm	8 mm	BN, SC, PC	aluminium
	128	150	23 mm	8 mm		

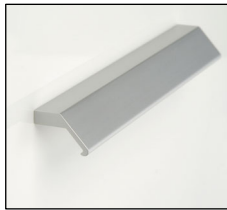

						
Code	Size CC	Overall Size	Projection	Width	Finish	Material
<b>4019</b>	96 mm	108 mm	32 mm	10 mm	BN,SN,SC	zinc alloy
	128 mm	140 mm	32 mm	10 mm		
	160 mm	172 mm	32 mm	10 mm		
	192 mm	204 mm	32 mm	10 mm		
	224 mm	236 mm	32 mm	10 mm		
	256 mm	268 mm	32 mm	10 mm		





**Siena**



						
Code	Size CC	Overall Size	Projection	Width	Finish	Material
<b>4020</b>	32	40 mm	25 mm	19 mm	SC	aluminium
	96	108	25 mm	19 mm		
	128	140	25 mm	19 mm		
	160	172	25 mm	19 mm		
	192	204	25 mm	19 mm		
	224	236	25 mm	19 mm		
	288	300	25 mm	19 mm		
	384	396	25 mm	19 mm		
	480	492	25 mm	19 mm		
	608	620	25 mm	19 mm		





**Estrada**

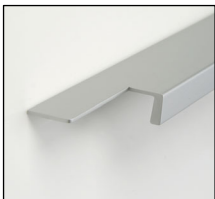

						
Code	Size CC	Overall Size	Projection	Width	Finish	Material
<b>4021</b>	60	60	40mm	8 mm	SC	aluminium
	120	120	40mm	8 mm		
	240	240	40mm	8 mm		
	400	400	40mm	8 mm		





**Estiva**

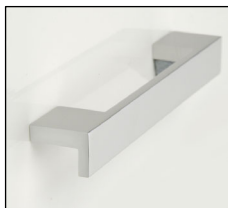

						
Code	Size CC	Overall Size	Projection	Width	Finish	Material
<b>4022</b>	300	300	35 mm	15 mm	SC	aluminium

**Avesta**



						
Code	Size CC	Overall Size	Projection	Width	Finish	Material
<b>4023</b>	96	116	24 mm	19 mm	SC, BN, PC	aluminium
	128	148	24 mm	19 mm		
	160	180	24 mm	19 mm		
	192	212	24 mm	19 mm		
	224	244	24 mm	19 mm		
	256	276	24 mm	19 mm		
	288	308	24 mm	19 mm		
	320	340	24 mm	19 mm		

### Aseda

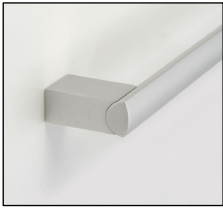

Code	Size CC	Overall Size	Projection	Width	Finish	Material
<b>4024</b>	96	110	35 mm	16 mm	SC and BN	aluminium
	128	142	35 mm	16 mm		
	160	174	35 mm	16 mm		
	192	206	35 mm	16 mm		
	224	238	35 mm	16 mm		
	256	270	35 mm	16 mm		
	288	302	35 mm	16 mm		
	352	366	35 mm	16 mm		
	416	430	35 mm	16 mm		
	512	526	35 mm	16 mm		
	608	622	35 mm	16 mm		
	736	750	35 mm	16 mm		
	960	974	35 mm	16 mm		

### Barhandles

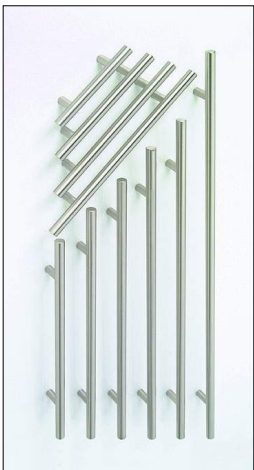

Code	Size CC	Overall Size	Projection	Diameter	Finish	Material
<b>2001115</b>	64 mm	115 mm	29 mm	12 mm	BN and SC	Bn = Stainless Steel SC = Steel
<b>2001155</b>	96 mm	155 mm	29 mm	12 mm		
<b>2001200</b>	128 mm	200 mm	29 mm	12 mm		
<b>2001250</b>	160 mm	250 mm	29 mm	12 mm		
<b>2001300</b>	192 mm	300 mm	29 mm	12 mm		
<b>2001350</b>	224 mm	350 mm	29 mm	12 mm		
<b>2001400</b>	288 mm	400 mm	29 mm	12 mm		
<b>2001450</b>	320 mm	450 mm	29 mm	12 mm		
<b>2001500</b>	360 mm	500 mm	29 mm	12 mm		
<b>2001600</b>	480 mm	600 mm	29 mm	12 mm		



Code	Size CC	Overall Size	Projection	Width	Finish	Material
BN2004108	96	108 mm	30 mm	12x12 mm	BN	<b>304 Stainless Steel</b>
BN2004140	128	140 mm	30 mm	12x12 mm		
BN2004172	160	172 mm	30 mm	12x12 mm		
BN2004204	192	204 mm	30 mm	12x12 mm		
BN2004236	224	236 mm	30 mm	12x12 mm		
BN2004268	256	268 mm	30 mm	12x12 mm		
BN2004300	288	300 mm	30 mm	12x12 mm		
BN2004332	320	320 mm	30 mm	12x12 mm		
BN2004364	352	352 mm	30 mm	12x12 mm		
BN2004396	384	384 mm	30 mm	12x12 mm		
BN2004428	416	416 mm	30 mm	12x12 mm		
BN2004492	480	480 mm	30 mm	12x12 mm		
BN2004524	512	512 mm	30 mm	12x12 mm		
BN2004620	608	608 mm	30 mm	12x12 mm		



**Knobs**

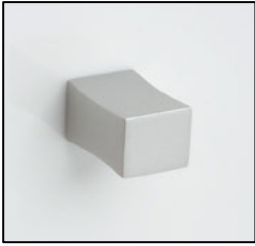

Code		Overall Size	Projection		Finish	Material
<b>3590</b>		15 x 14 mm	23 mm		SC	aluminium



Code		Diameter	Projection		Finish	Material
<b>3595</b>		27 mm	25 mm		SC	aluminium



Code	size		Projection	Diameter	Finish	Material
<b>1160</b>	S		23 mm	17 mm	BN,SN,SC	zinc alloy
	L		26 mm	25 mm		



Code		Overall Size	Projection	Width	Finish	Material
<b>1164</b>		35 mm	18 mm	8 mm	SC	zinc alloy



Code	size		Projection	Diameter	Finish	Material
<b>1165</b>	S		17 mm	24 mm	BN,SN,SC	zinc alloy
	L		26 mm	29 mm		



Code			Projection	Diameter	Finish	Material
<b>1166</b>			16 mm	17 mm	BN,SN,SC	zinc alloy



Code	Size CC	Overall Size	Projection	Width	Finish	Material
<b>1168</b>	32 mm	44 mm	20 mm	8 mm	BN,SN,SC	zinc alloy



Code	size		Projection	Diameter	Finish	Material
<b>1172</b>	S		16 mm	11 mm	BN,SN,SC	zinc alloy
	L		19 mm	14 mm		



Code			Projection	Diameter	Finish	Material
<b>1179-22</b>			28 mm	22 mm	BN	zinc alloy

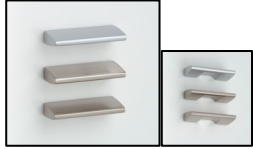

Code	Size CC	Overall Size	Projection		Finish	Material
<b>1187</b>	32 mm	56 mm	25 mm		BN,SN,SC	zinc alloy

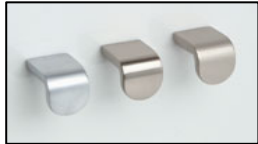

Code			Projection	Width	Finish	Material
<b>1194</b>			25 mm	20 x 21 mm	BN,SN,SC	zinc alloy



Code			Projection	Diameter	Finish	Material
<b>1208</b>			22 mm	28 mm	BN,SN,SC	zinc alloy

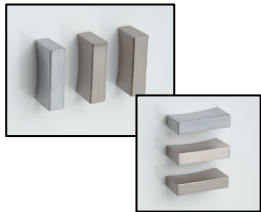

Code	Size CC	Overall Size	Projection	Width	Finish	Material
<b>1299</b>	32 mm	41 mm	20 mm	10 mm	BN,SN,SC	zinc alloy



Code		Overall Size	Projection	Width	Finish	Material
<b>2049</b>		51 mm	13 mm	9 mm	BN,SN,SC	zinc alloy

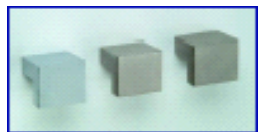

Code			Projection	Width	Finish	Material
<b>1112</b>			20 mm	25 x 25 mm	BN,SN,SC	zinc alloy



Code			Projection	Width	Finish	Material
<b>1114</b>			24 mm	19 x 19 mm	BN,SN,SC	zinc alloy

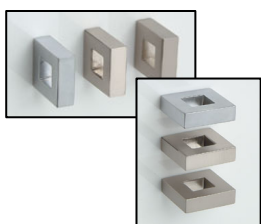

Code		Overall Size	Projection	Width	Finish	Material
<b>1115</b>		25 x 25	24 mm	9 mm	BN,SN,SC	zinc alloy

## Flush Pulls



Code		Overall Size	Projection	Grove	Finish	Material
<b>1159</b>		41 mm diam.	7 mm	25 mm diam.	BN,SN,SC	zinc alloy



Code	Size CC	Overall Size	Projection	Grove	Finish	Material
<b>1132</b>	64 mm	76x42 mm	10 mm	18x48 mm	BN,SN,SC	zinc alloy
	96 mm	108x42 mm	10 mm	18x80 mm		
	128 mm	142x42 mm	10 mm	18x111 mm		



Code		Overall Size	Projection	Grove	Finish	Material
<b>1141</b>		100 x 38 mm	13 mm	68 x 18 mm	BN,SN,SC	zinc alloy
		135 X 38 mm	13 mm	95 x 18 mm		
		165 x 50 mm	13 mm	115 x 25 mm		



Code	Size CC	Overall Size	Projection		Finish	Material
<b>1150</b>	160 mm	171x52 mm	14 mm		SC	zinc alloy

*for 18 mm board only*



Code		Overall Size	Projection	Grove	Finish	Material
<b>3038S</b>	24 mm	26 x 26 mm	11 mm	16 x 16 mm	BN,SN,SC	zinc alloy

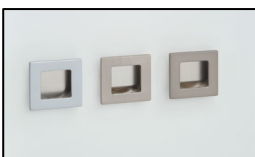

Code		Overall Size	Projection	Grove	Finish	Material
<b>3038L</b>	40 mm	46 x 46 mm	11 mm	26 x 26 mm	BN,SN,SC	zinc alloy

### Triple hook



Code					Finish	Material
<b>5018</b>					BN,SN,SC	zinc alloy

### Doorstops



Code		Diameter	Height		Finish	Material
<b>5019</b>		25 mm	70 mm		BN	zinc alloy

Magnetic doorstop, interior only



Code		Diameter	Height		Finish	Material
<b>5025</b>		47 mm	25 mm		BN, SC	zinc alloy



Code		Diameter	Length		Finish	Material
<b>5029</b>		30 mm	76 mm		BN, SC	zinc alloy

doorstop without catch



Code		Diameter	Length		Finish	Material
<b>5029C</b>		30 mm	76 mm		BN, SC	zinc alloy

doorstop with catch



Code		Diameter	Height		Finish	Material
<b>5031</b>		19 mm	50 mm		BN	stainless steel



Code		Diameter	Height		Finish	Material
<b>5034</b>		10 mm	83 mm		BN, SC	zinc alloy